

AF09 ... AF16 3-polige Schütze

Wechselstrombetätigung/ Gleichstrombetätigung – mit Schraubklemmen

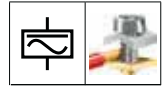

1

Abmessungen mm, Zoll

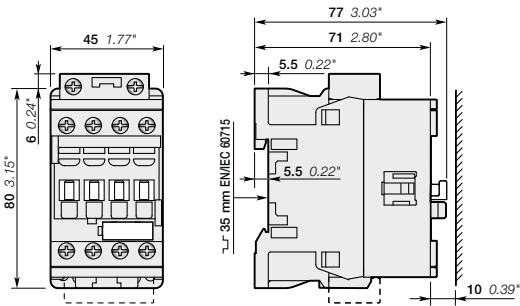

AF09, AF12, AF16

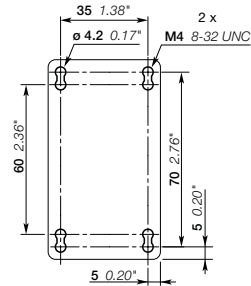

AF09, AF12, AF16

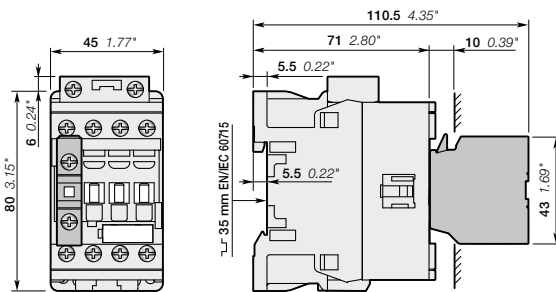

AF09, AF12, AF16
+ CA4, CC4 1-poliger Hilfskontaktblock

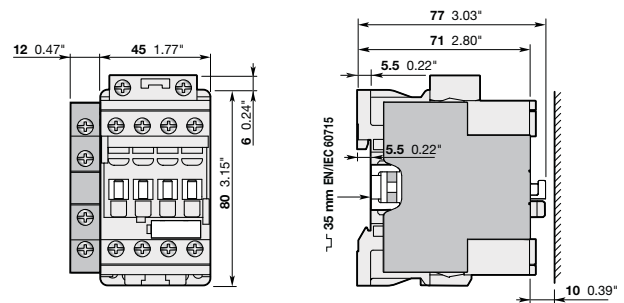

AF09, AF12, AF16
+ CAL4-11 2-poliger Hilfskontaktblock

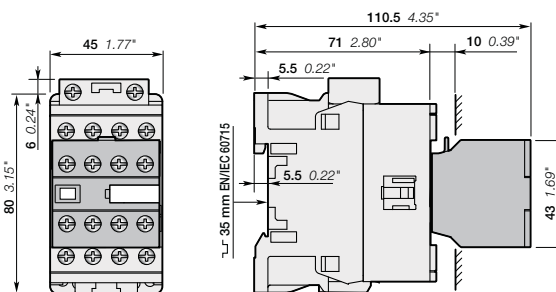

AF09, AF12, AF16
+ CA4 4-poliger Hilfskontaktblock

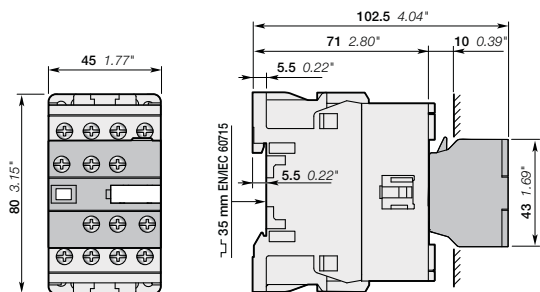

AF09, AF12, AF16
+ CAT4 2-poliger Hilfskontaktblock und Spulenanschlussklemmen

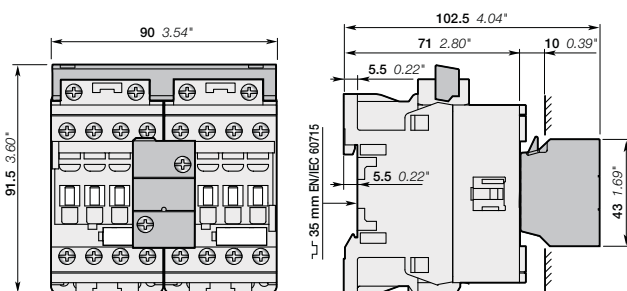

AF09, AF12, AF16
+ VEM4 mechanischer und elektrischer Verriegelungssatz

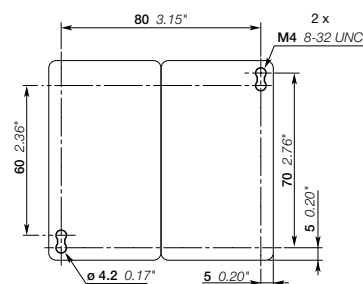

AF09, AF12, AF16
+ VEM4 mechanischer und elektrischer Verriegelungssatz

Hinweis: seitlicher Abstand des Schütz zu geerdeten Komponenten 2 mm 0.08" min.

AF26 ... AF38 3-polige Schütze

Wechselstrombetätigung/
Gleichstrombetätigung – mit Schraubklemmen



Abmessungen mm, Zoll

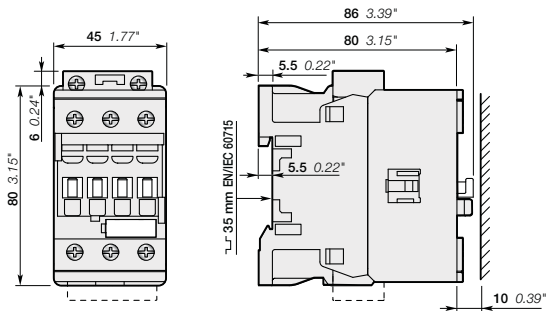

AF26, AF30, AF38

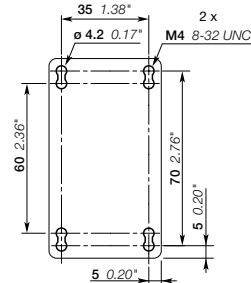

AF26, AF30, AF38

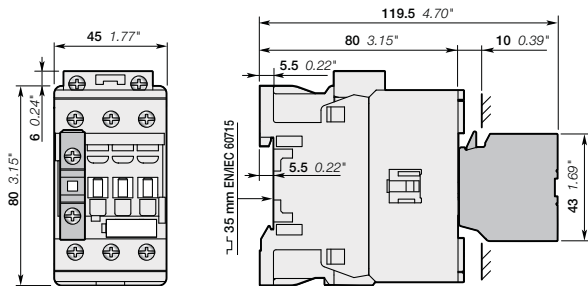

AF26, AF30, AF38
+ CA4, CC4 1-poliger Hilfskontaktblock

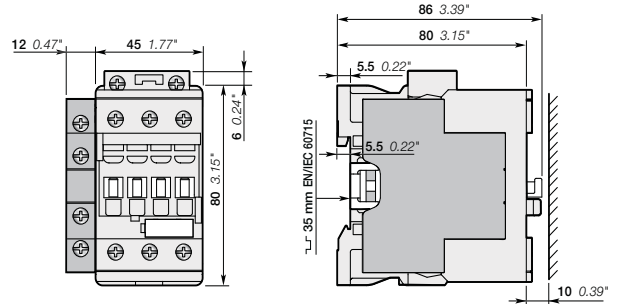

AF26, AF30, AF38
+ CAL4-11 2-poliger Hilfskontaktblock

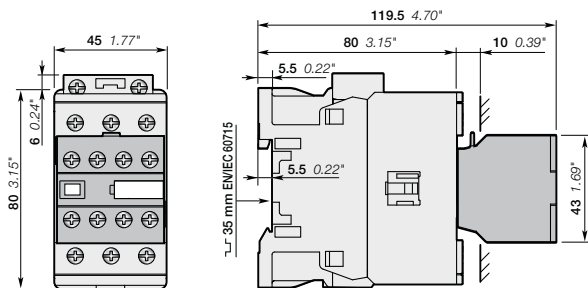

AF26, AF30, AF38
+ CA4 4-poliger Hilfskontaktblock

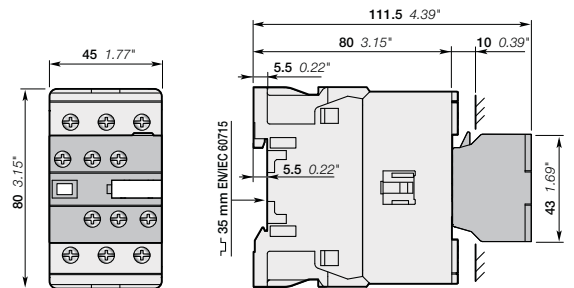

AF26, AF30, AF38
+ CAT4 2-poliger Hilfskontaktblock und Spulenanschlussklemmen

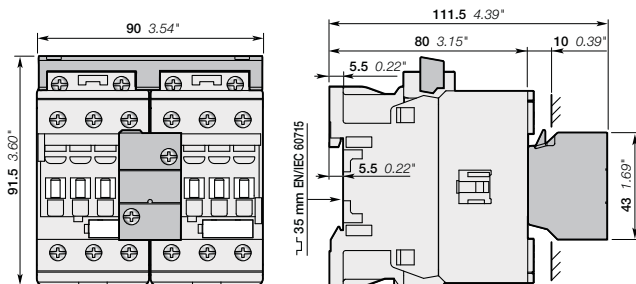

AF26, AF30, AF38
+ VEM4 mechanischer und elektrischer Verriegelungssatz

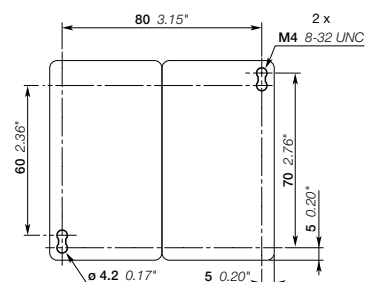

AF26, AF30, AF38
+ VEM4 mechanischer und elektrischer Verriegelungssatz

Hinweis: seitlicher Abstand des Schütz zu geerdeten Komponenten 2 mm 0.08" min.

Wichtigste Abmessungen (mm, Zoll)

AF09, AF12, AF16 3-polige Schütze
+ TF42 thermisches Überlastrelais

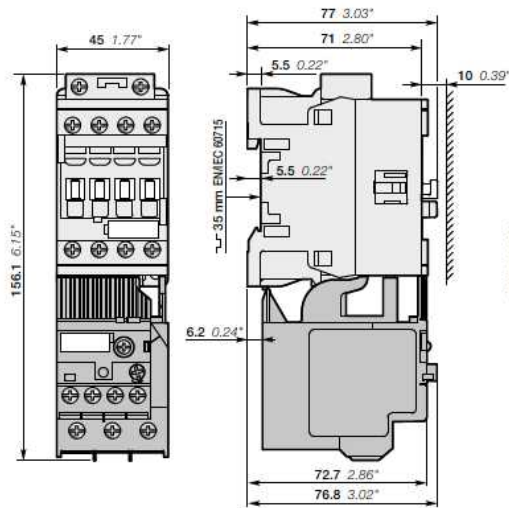

AF26, AF30, AF38 3-polige Schütze
+ TF42 thermisches Überlastrelais

