

Ansicht "A"

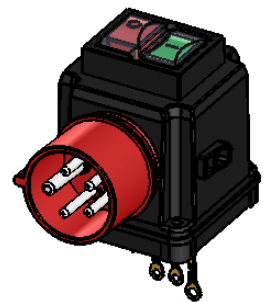
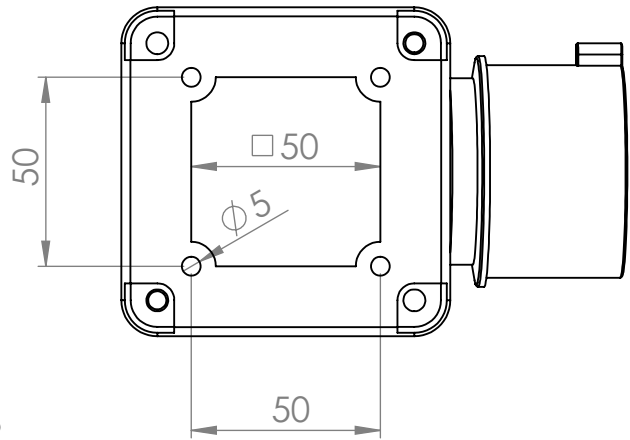

			Tag	Name	Bezeichnung
			Bearb. 08.10.2013	Krämer	0098.9030
			Gepr.		
Ind. Änderung	Tag	Name	KLINGER BORN		ZgNr. G:\SW\Ma\Ku\Intern\00989030\