

Ansicht "A"

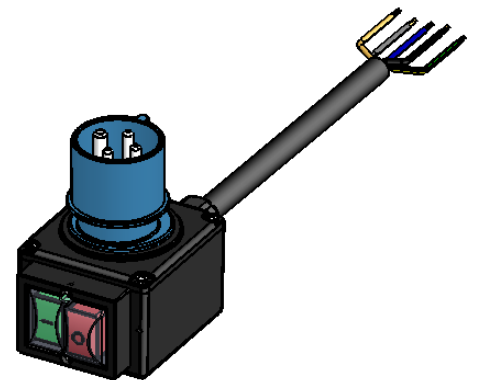
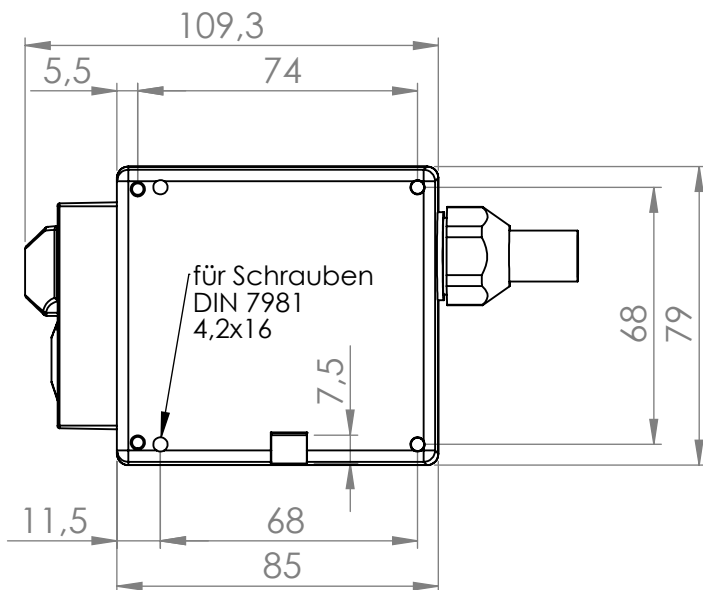

			Tag	Name	Bezeichnung
			Bearb. 27.09.2013	Krämer	0098.5940
			Gepr.		
Ind. Änderung	Tag	Name	KLINGER BORN		ZgNr. G:\SW\Ma\Ku\Intern\00985940\