

Ansicht "A"

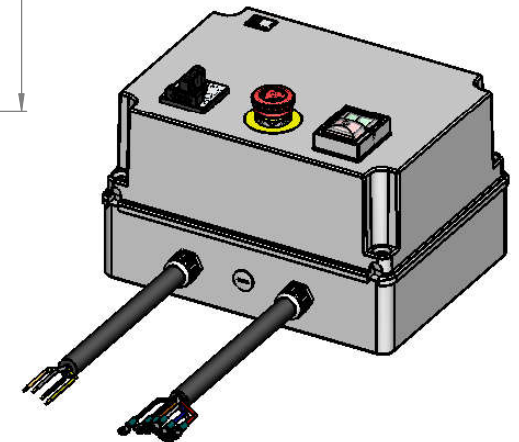
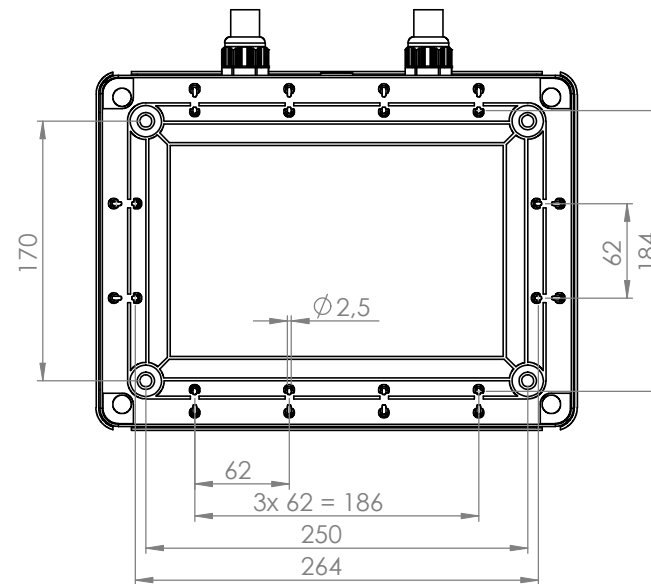
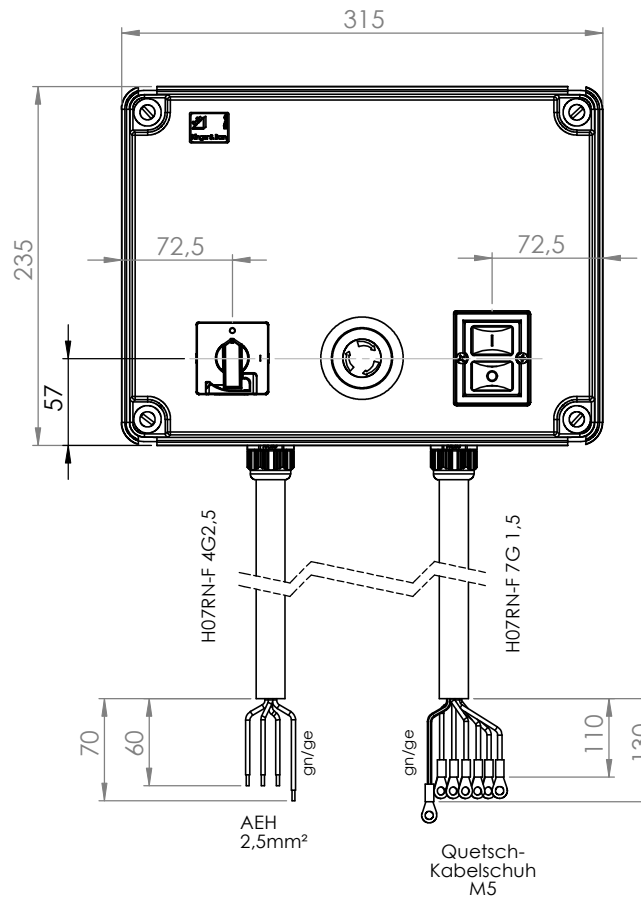

			Tag	Name	Bezeichnung 0098.4017
		Bearb.	13.01.2014	Krämer	
		Gepr.			
Ind. Änderung	Tag	Name			ZgNr. G:\SW\Ma\Ku\Intern\00984017\